



PO Box 128 | 504 Highway 63 South | Freeburg, MO 65035 | 800-347-0438 | 573-469-4151 (fax)

## Installation Guidelines for All Aluminum Quaker Products with Pre-set Panning

Read these instructions completely before starting any installation. Failure to install and maintain our product according to these instructions may void any product warranty. Please visit our website at [www.quakerwindows.com](http://www.quakerwindows.com) or call 1-800-347-0438 for additional information.

### Tools required by installer:

Safety Glasses		Utility Knife	
Drill/Driver		Caulk Gun	
Level		Tape Measure	
Hammer		Pliers	
Metal cutting saw			

### Materials required by installer:

Foam Backer Rod		Minimally Expanding Foam	
Shims (Waterproof)		Sealant	
Fasteners		IPA Alcohol	

## ⚠ WARNING

### Tools

- Follow manufacturer’s instructions for safe operation of tools, and ladders/scaffolding. Always wear safety glasses. Failure to do so could result in injury, product or property damage.

### Handling

- Do not store units outside, or in a hot environment. Doing so could result in product damage.
- Do not carry flat.** Doing so could result in product damage, injury, or property damage.
- Stack units as straight as possible to avoid bowing. **Do not lay flat!**

### Glass

- If broken, glass can fragment causing injury. All Quaker products are available with safety glass. In many areas, local building codes require safety glass in certain locations and/or applications. Unless safety glass is ordered, Quaker windows are not provided with safety glass. Before ordering, consult your local building codes for more definitive information.

### Fastening

- Metal fasteners and components could corrode when used with preservative-treated lumber. Use approved fasteners and components to fasten window or door. Failure to do so could cause a failure resulting in injury, product or property damage.
- Fastener must attach to a structural framing member with 1 1/2” minimum fastener embedment, or minimum 3 full threads with a minimum 5/16” head as products were tested with.
- Quaker does not supply anchorage/fastener calculations, and is not responsible for determining structural adequacy of the anchorage and fasteners used to install our products, or the openings into which they are installed.**
- Do not** over drive screws or nails. Doing so could result in product damage.

**CAUTION****Installation**

- Always support window or door in opening until fully fastened. Failure to do so could result in the window or door falling out or causing injury, product, or property damage.
- Nailing flanges and drip caps (integral or applied) **do not** take the place of window flashing. All windows and doors must be properly flashed and sealed with material compatible sealant for protection against water and air infiltration around the entire perimeter. Failure to do so could result in product or property damage.
- **Do not** set window directly on sill plate. Place shims under the side jambs. Window or door must be properly shimmed. Failure to do so could affect operation and product performance and could result in product damage.
- Live or dead loads transferred into our product can affect functionality, damage frame joinery or cause glass failures. Dead loads such as upper levels, roof, etc. Should be constructed before window or door is installed.
- Loads shall be designed to withstand the most critical effects of load factors and load combinations as required by the building code. (Loads are including but not limited to Live, Dead, Collateral, Auxiliary, Thermally induced, Seismic, etc.)
- Maximum vertical deflection of the header under all Load combination should not exceed the Span/720 or 1/4" whichever is less.
- Windows and doors have small parts. Small parts if swallowed could pose a choking hazard to young children. Dispose of unused, loose, or easily removed small parts. Failure to do so could result in injury.
- **Do not** drill through or into window sill to install alarm wires.

**Sealing**

- Follow instructions of foam, sealant, and flashing manufacturers regarding safety, material application, compatibility, and periodic maintenance for continued weather resistance of their products. Failure to do so could result in product or property damage. **DO NOT** overfill between the frame and opening.
- Minimally expanding foam insulation must be compliant with AAMA 812-19.
- Quaker recommends 100% silicone (ASTM C920 compliant) neutral cure only sealant. Always clean all areas where sealant will be applied. Failure to do so could result in product or property damage.
- Flashing tape must meet ASTM-D779 performance requirements.
- Maintain a minimum of 1/4" between the window or door frame and exterior finish materials. Failure to do so could result in product or property damage.

**Joining**

- Do not join any window or door to any window or door not designed for joining. Joined windows and doors must be individually supported in the opening. Failure to do so could affect operation and product performance and could result in product or property damage.

**Cleaning**

- Acid solutions used for cleaning will damage glass, fasteners, hardware, and metal flashing. Protect these products and follow cleaning products manufacturers instructions. If acid contacts the window or door, wash all surfaces immediately with clean water.
- **Do not** use razor blades to clean glass surface. Glass damage could result.
- Clean glass using liquid glass cleaner.
- Clean frame, sash, panels, and insect screens using mild detergent and warm water with a soft cloth or brush.

**IMPORTANT**

- Buildings constructed prior to 1978 could contain lead paint which could be disturbed during window or door replacement. For more information on proper management of lead paint, go to: [www.epa.gov/lead](http://www.epa.gov/lead)
- Care must be taken to properly recycle or dispose of old materials. Any recyclable materials should be separated from non-recyclable or hazardous materials. Please consult with local or state authorities regarding proper disposal of non-recyclable or hazardous materials.
- These are generic instructions intended to cover most common situations, which may not be appropriate for all installations due to building design, construction materials, or methods used and/or building or site conditions. Consult a contractor or architect for recommendations.
- Inspect all units for any damage or defects prior to installation. Contact the nearest Quaker distributor if there are any problems.

1

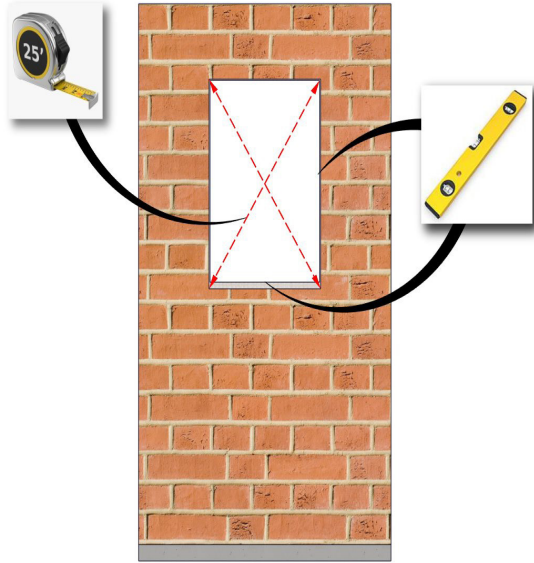

Measure and verify the size of the rough opening. See shop drawings for the proper opening sizes per panning system being used. Verify the rough opening is flat, plumb, level, and square. Take diagonal measurements to check for square within 1/8". The sill beneath the unit must be level for proper unit operation.

2

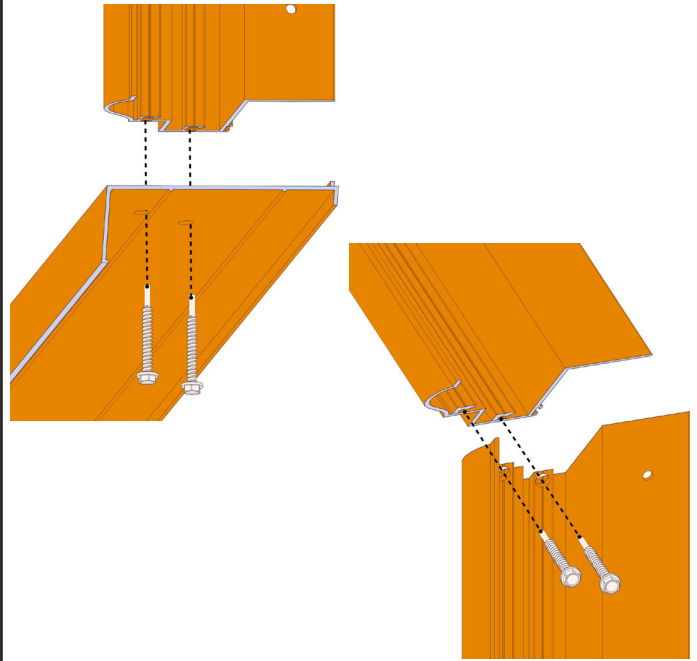

Assemble sill panning to panning jamb, and jamb to panning head using two of the supplied screws at each corner. Screw through the holes in sill and jamb into the screw bosses.

3

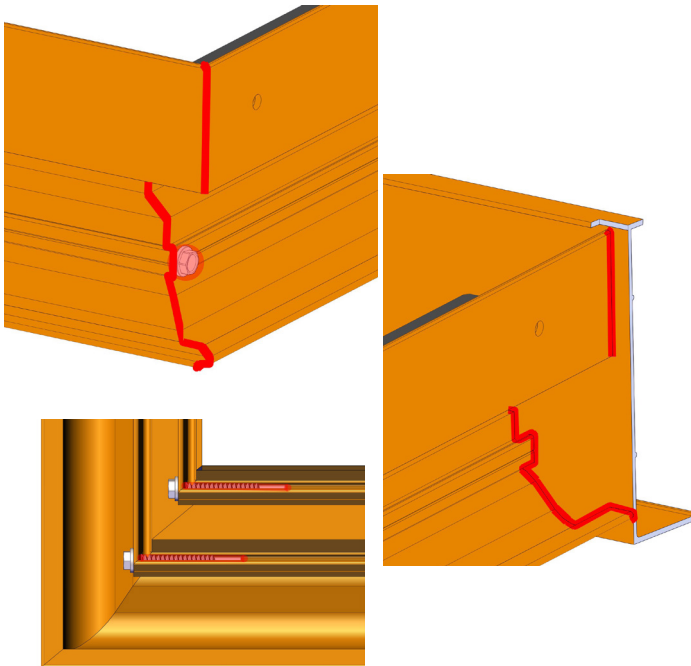

Back seal all four outside corners of the panning. Completely cover the miters, screw heads and exposed screw bodies with sealant.

4

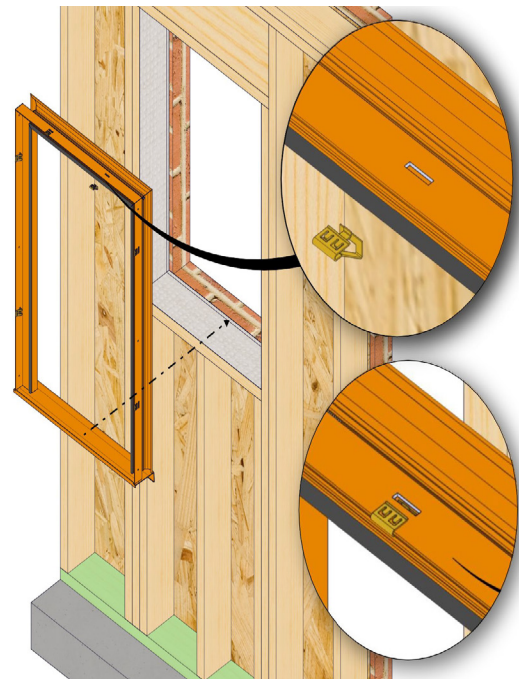

Install the panning clips (shipped separately from panning) per the above image. Check the fit of the panning making sure the conditions are level and shim as needed to achieve level.



5

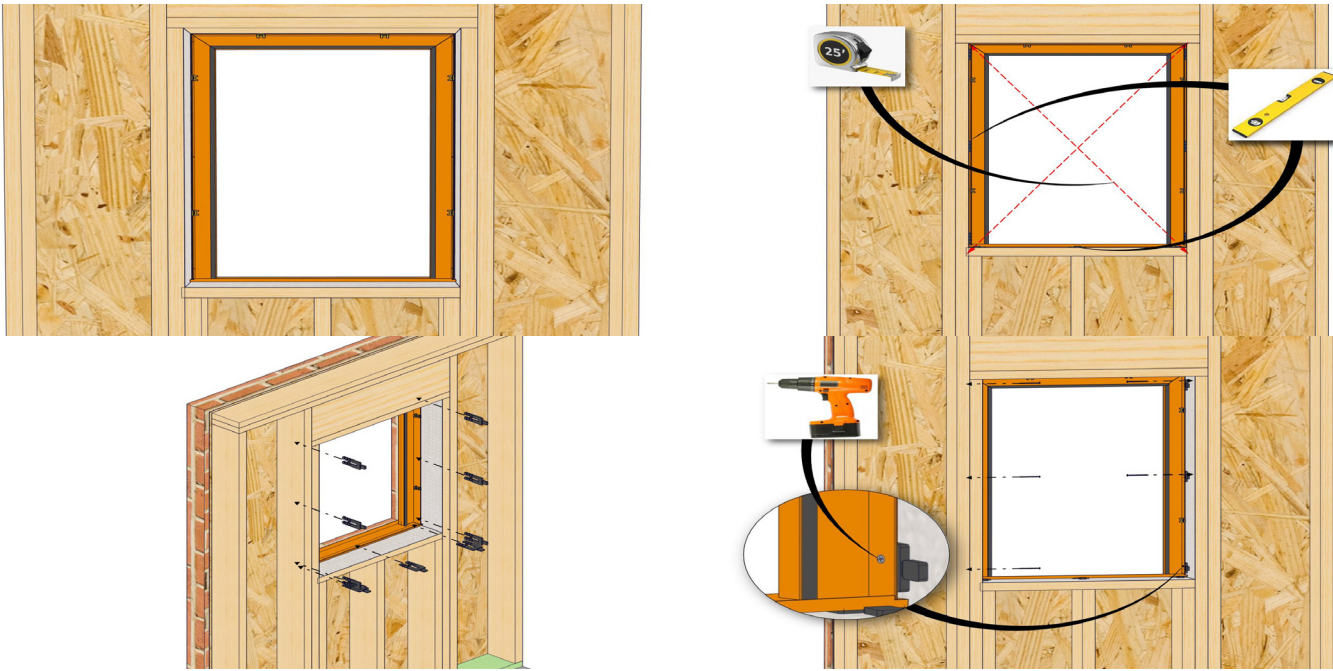

Measure the Masonry opening and trim the exterior face of panning legs as needed to fit openings. Shim as needed to square, plumb, and level the panning into the opening. Fasten the panning with screws by others per shop drawings or anchorage calculations. Flathead screw recommended for fastening of panning to allow clearance for window frame to be installed typically 3" from the corners and 12" on center. Always follow the fastener/anchor manufacture's guidelines for proper edge distance, load capacity and installation techniques.

6

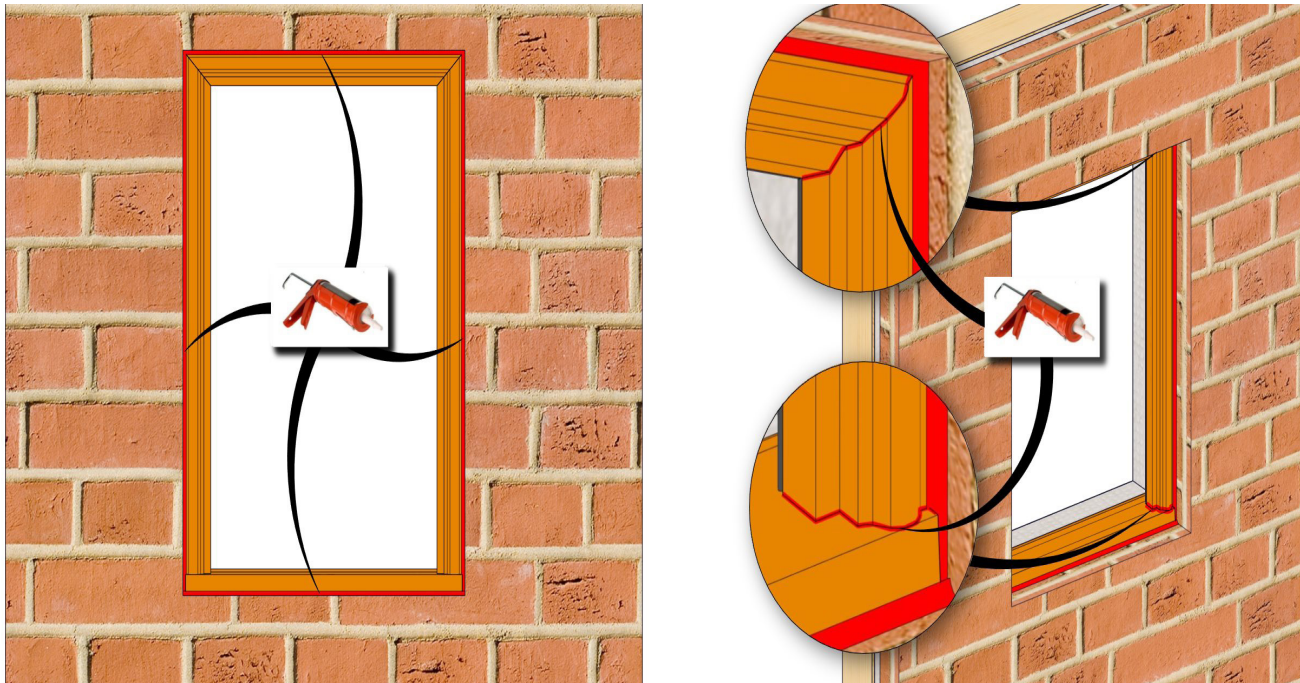

Apply sealant to the perimeter of the panning system (3/8" caulk joint) to the surrounding masonry opening, and all seams in the panning system.

7

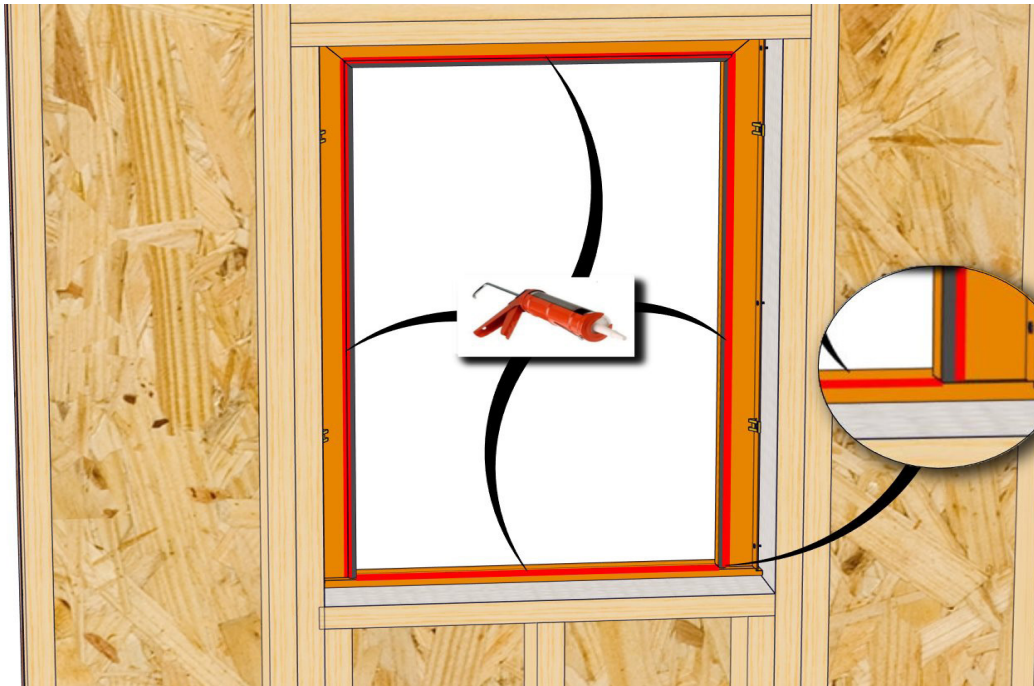

Apply a continuous bead of sealant along the sill panning where the exterior window leg will rest. Back seal the panning vinyl with sealant just before inserting the window, or cap seal the window to the panning frame joint from the exterior after the window is installed.

Whichever method is used, the window must be wet sealed to the panning. The panning vinyl is not a stand-alone weather seal. Insulate around perimeter between the panning and wall system.

8

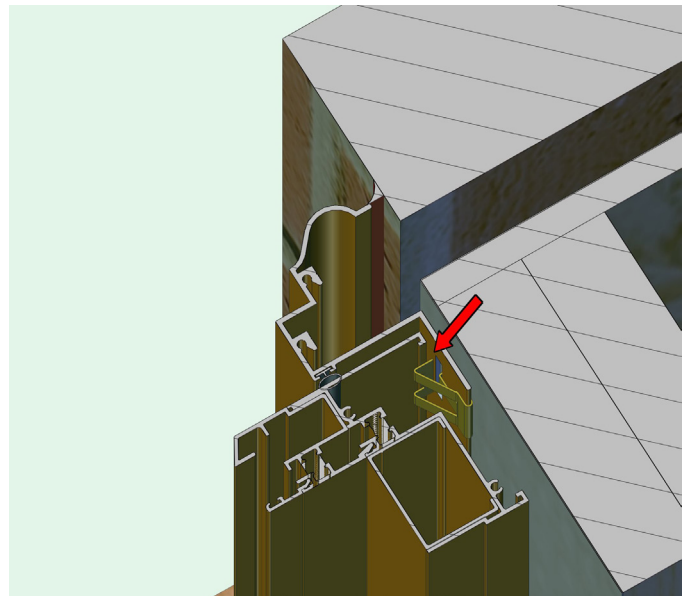
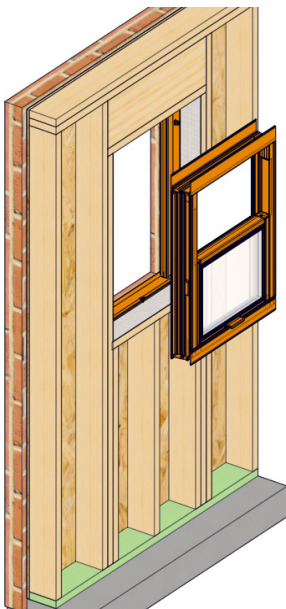

Set the exterior leg of the window onto the sill panning frame. Then push the window head and jamb in against the panning head and jamb. Make sure that the window head and jamb legs snap-in securely behind panning clips. The window must be pushed tight against the panning.



9

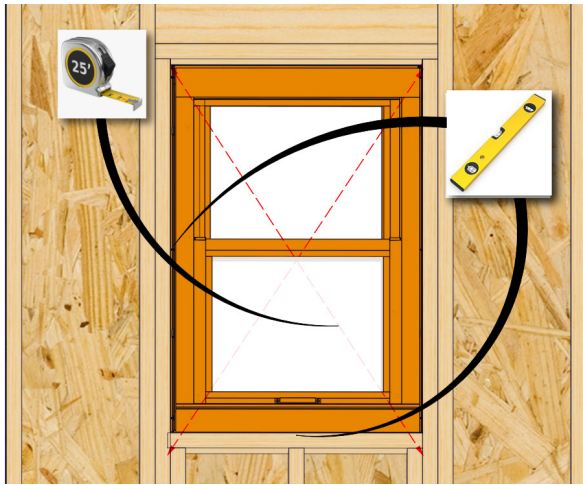

Place a level on the window sill to verify that the sill is level. Adjust the shims as needed to ensure a level condition. Check the head, sill and jambs with a level again to make sure the window is setting plumb, level, and square within the opening. Measure across the diagonals to determine if the window is square. Add shims around the entire window as needed to ensure a plumb, level, and square installation.

10

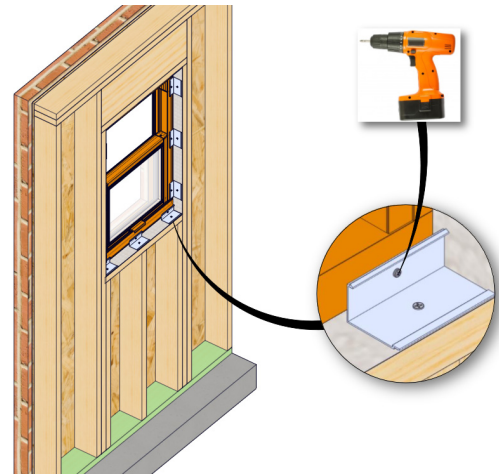

Install base clips around the window per shop drawings and or anchorage calculations - fasten to window before wall/framing to ensure good compression against the panning. Typically 3" from the corners and 12" on center. Keep base clips tight against the window and wall/framing system. Minimum one screw into the window frame, and one screw into the wall/framing system per base clip. Use caution when attaching the clips to the frame – be sure not to interrupt the travel of the sash by penetrating the tracks in jambs or the sill. Always follow the fastener/anchor manufacturer's guidelines for proper edge distance, load capacity and installation techniques.

11

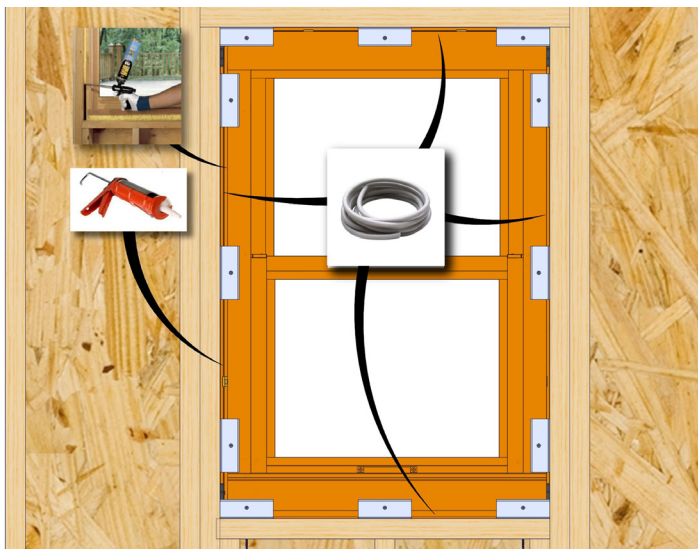

Insulate between the window frame and the rough opening using minimally expanding window and door spray foam or fiberglass insulation that is compliant with AAMA 812-04. Apply sealant continuously around entire perimeter of opening after foam or insulation is installed. Read and follow the manufacturers' recommendations for application and use. Measure and trim the snap covers to fit the opening, widths then heights. Install the snap trim covers to finish the interior.



# Installation Guidelines

## For All Aluminum Quaker Products With Pre-Set Panning Installation

If this set of instructions doesn't match your installation method or wall conditions please check our website listed below for other options, or call the office.

Scan here for a digital version of these guidelines in English



Or go to: <https://www.quakercommercialwindows.com/resources/installation-instructions-english/>

Scan here for a digital version of these guidelines in Spanish

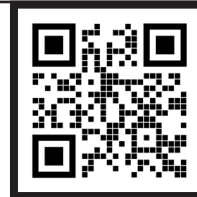

Or go to: <https://www.quakercommercialwindows.com/installation-instructions-spanish/>

